



SD101AW

SCHOTTKY BARRIER DIODE

主要特征/Features

- ◇ Surface Mount SOD-123 Package ;
- ◇ Low Forward Voltage Drop;
- ◇ Fast Switching Time;
- ◇ RoHS compliant / Green EMC;

印字/MARKING 等效电路/Equivalent Circuit

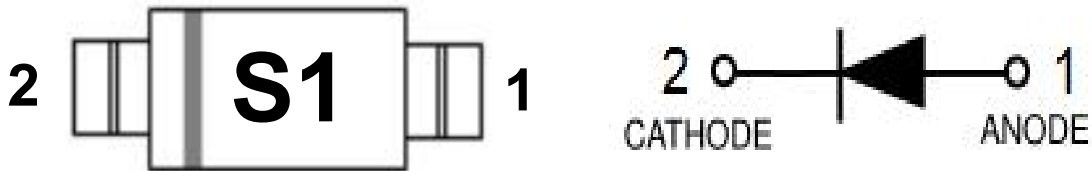

极限参数/Absolute Maximum Ratings(TA=25°C unless otherwise noted)

参数 Parameter	符号 Symbol	数值 Value	单位 Unit
Peak Repetitive Peak Reverse Voltage	V_{RRM}		
Working Peak Reverse Voltage	V_{RWM}	60	V
DC Blocking Voltage	V_R		
RMS Reverse Voltage	$V_{R(RMS)}$	42	V
Forward Continuous Current	I_{FM}	15	mA
Repetitive Peak Forward Current	@t<1.0s	50	mA
	@t=10μs	2.0	A
Power Dissipation	P_d	400	mW
Thermal Resistance Junction to Ambient	$R_{\theta JA}$	250	°C/W
Junction Temperature	T_j	125	°C
Storage Temperature	T_{STG}	-55~+150	°C



电性能参数/Electrical Characteristics (TA=25°C unless otherwise noted)

参数 Parameter	符号 Symbol	测试条件 Conditions	最小值 Min	典型值 Typ	最大值 Max	单位 Unit
Reverse Breakdown Voltage	V_R	$I_R=10\mu A$	60			V
Reverse Current	I_R	$V_R=50V$			0.2	μA
Forward Voltage	V_{F1}	$I_{F1}=1.0mA$			0.41	V
	V_{F2}	$I_{F2}=15mA$			1.00	V
Reverse recovery time	trr	$I_F=I_R=5mA$ $I_{rr}=0.1 \times I_R$ $R_L=100\Omega$			1.0	ns
Capacitance between terminals	C_T	$V_R=0V, f=1MHz$			2.0	pF



典型特性曲线图/Typical Characteristics

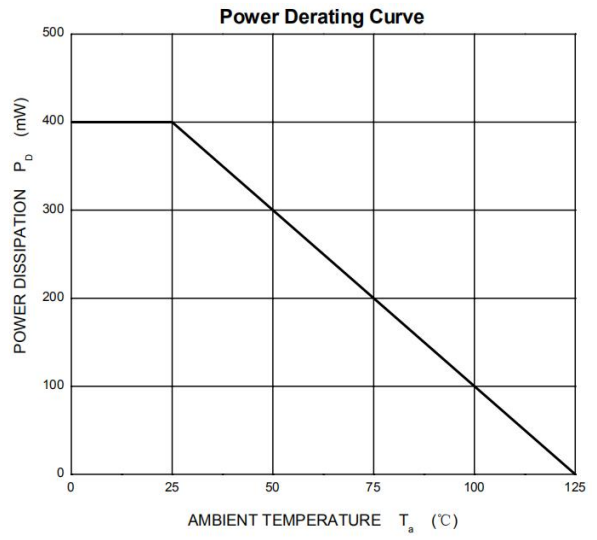
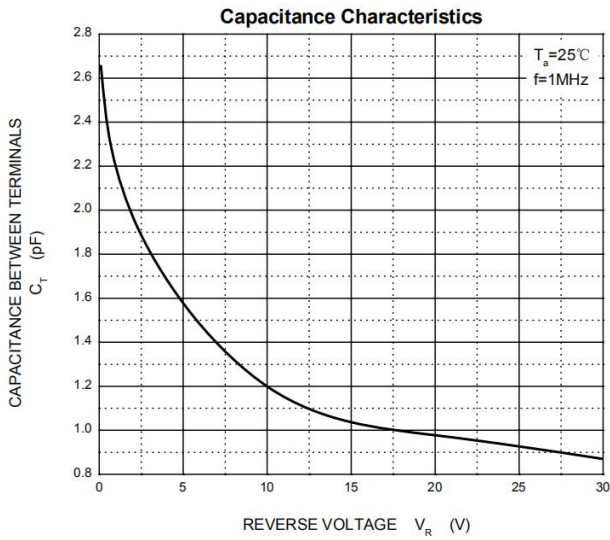
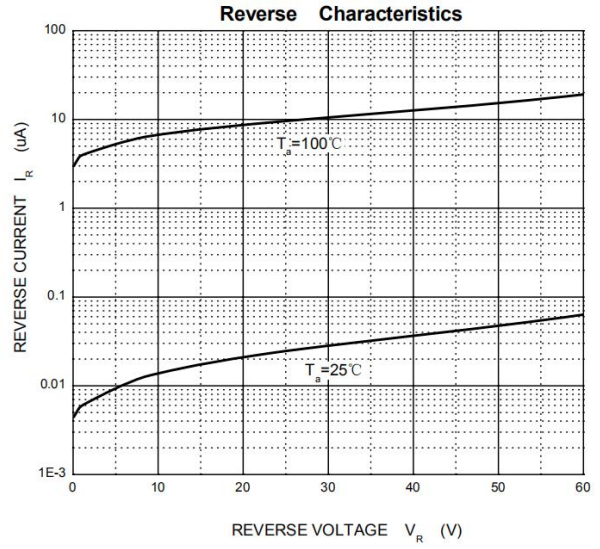
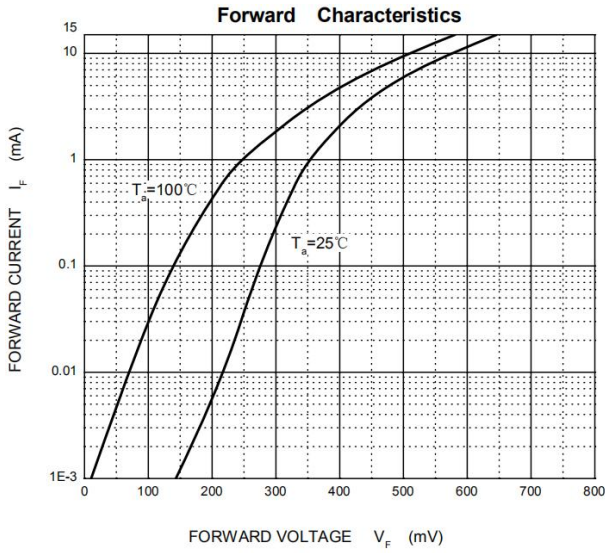



成品外观尺寸/SOD-123 Package Information

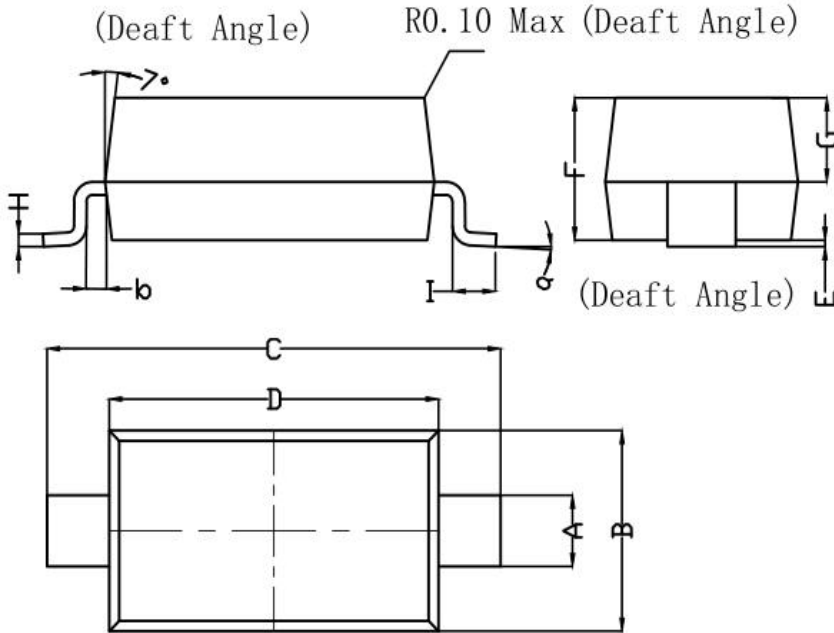

Symbol	Dim in mm		
	Min	Nom	Max
A	0.520	0.550	0.570
B	1.400	1.550	1.700
C	3.350	3.650	3.850
D	2.550	2.650	2.850
E	0.000	0.050	0.100
F	1.050	1.100	1.150
G	0.620	0.650	0.670
H	0.100	0.110	0.120
I	0.250	0.350	0.450
a	0°	-	6°
b	0.4°	-	0.8°

Mold Surface roughness <4um

出货规范/Shipping Specifications

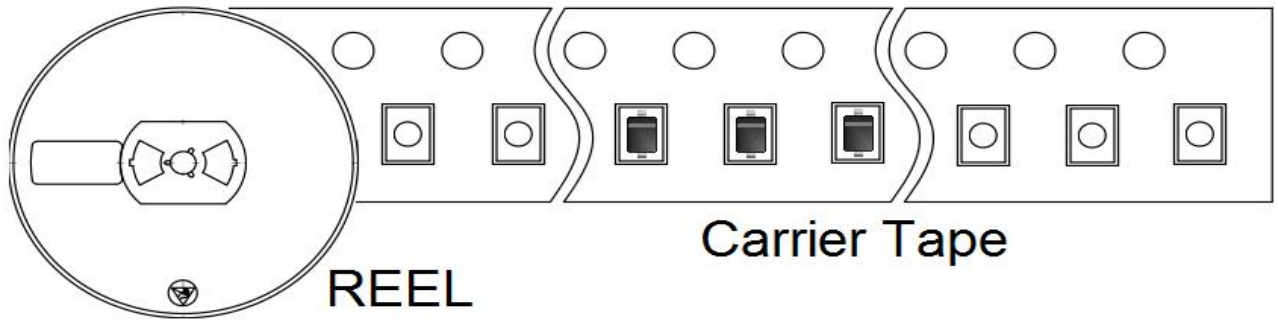

×15



×4



Reel	Reel Size	Box	Box Size(mm)	Carton	Carton size(mm)
3000 Pcs	7 inch	45 KPcs	185×185×188	180 KPcs	400×400×210