



# SD103BW

## SCHOTTKY BARRIER DIODE

### 主要特征/Features

- ◇ Surface Mount SOD-123 Package ;
- ◇ Low Forward Voltage Drop;
- ◇ Negligible Reverse Recovery Time;
- ◇ RoHS compliant / Green EMC;

### 印字/MARKING 等效电路/Equivalent Circuit

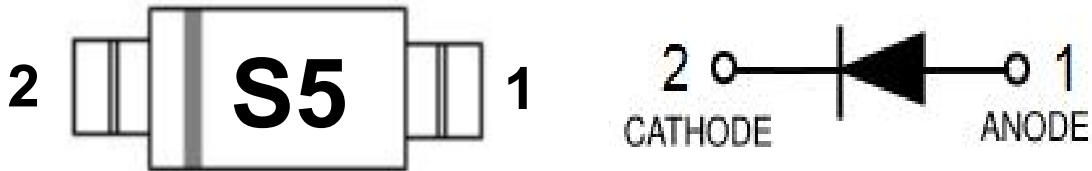

### 极限参数/Absolute Maximum Ratings(TA=25°C unless otherwise noted)

参数 Parameter	符号 Symbol	数值 Value	单位 Unit
Peak Repetitive Reverse Voltage	$V_{RRM}$	30	V
Working Peak Reverse Voltage	$V_{RWM}$		
RMS Reverse Voltage	$V_{R(RMS)}$	21	V
Forward Continuous Current	$I_{FM}$	350	mA
Non-repetitive Peak Forward Surge Current @ $t \leq 1s$	$I_{FSM}$	2	A
Power Dissipation	$P_d$	400	mW
Thermal Resistance from Junction to Ambient	$R_{\theta JA}$	250	°C/W
Junction Temperature	$T_j$	125	°C
Storage Temperature	$T_{STG}$	-55~+150	°C



电性能参数/Electrical Characteristics (TA=25°C unless otherwise noted )

参数 Parameter	符号 Symbol	测试条件 Conditions	最小值 Min	典型值 Typ	最大值 Max	单位 Unit
Reverse Voltage	$V_R$	$I_R=100\mu A$	30			V
Forward Voltage	$V_{F1}$	$I_{F1}=20mA$			0.37	V
	$V_{F2}$	$I_{F2}=200mA$			0.6	V
Reverse Current	$I_R$	$V_R=20V$			5	$\mu A$
Total capacitance	$C_{TOT}$	$V_R=0V, f=1MHz$		50		pF
Reverse recovery time	trr	$I_F=I_R=200mA$ $I_{rr}=0.1 \times I_R$ $R_L=100\Omega$		10		ns



典型特性曲线图/Typical Characteristics

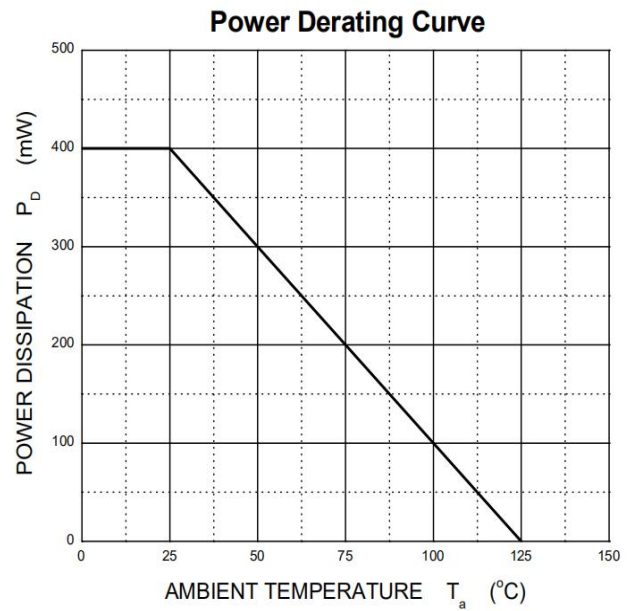
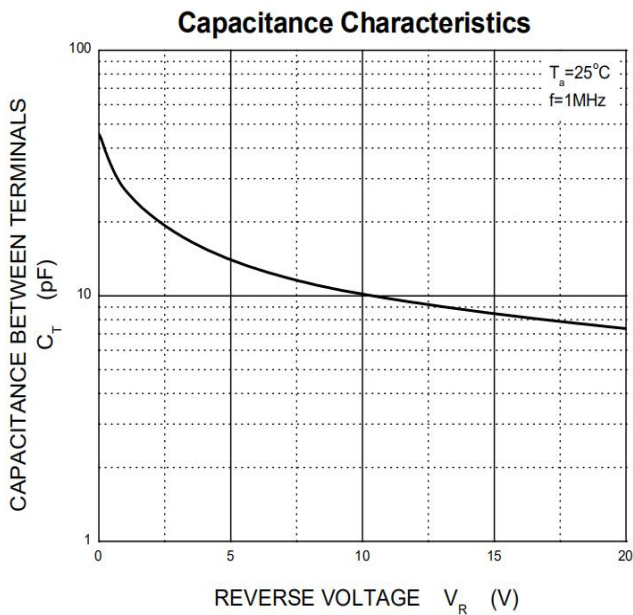
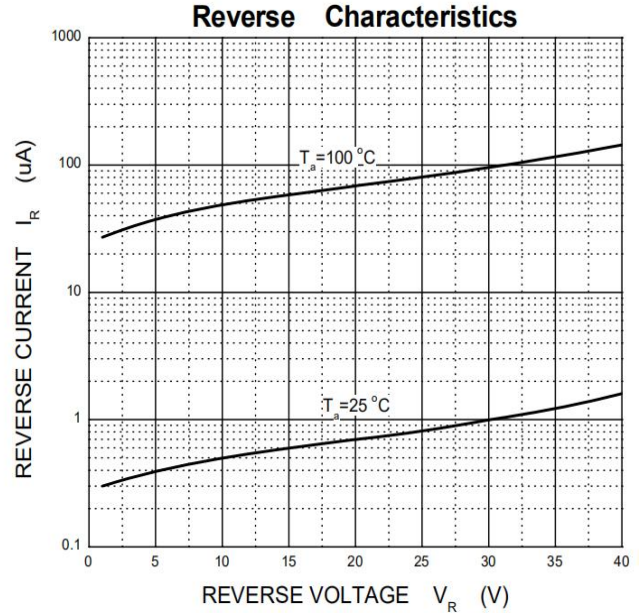
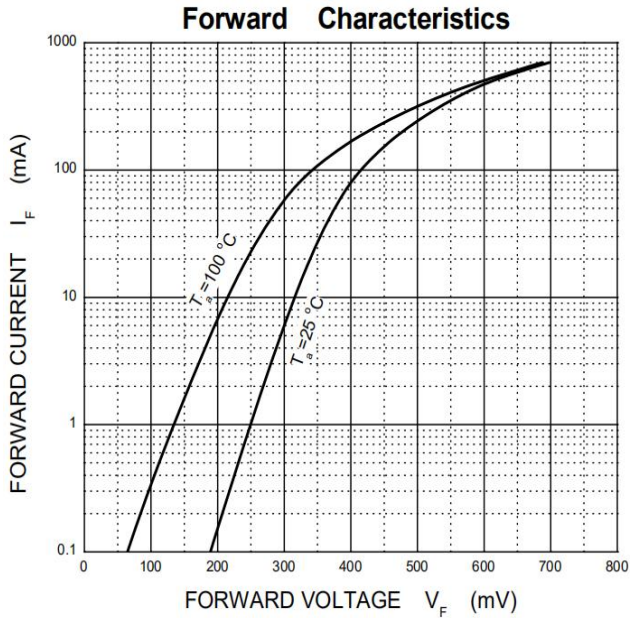



成品外观尺寸/SOD-123 Package Information

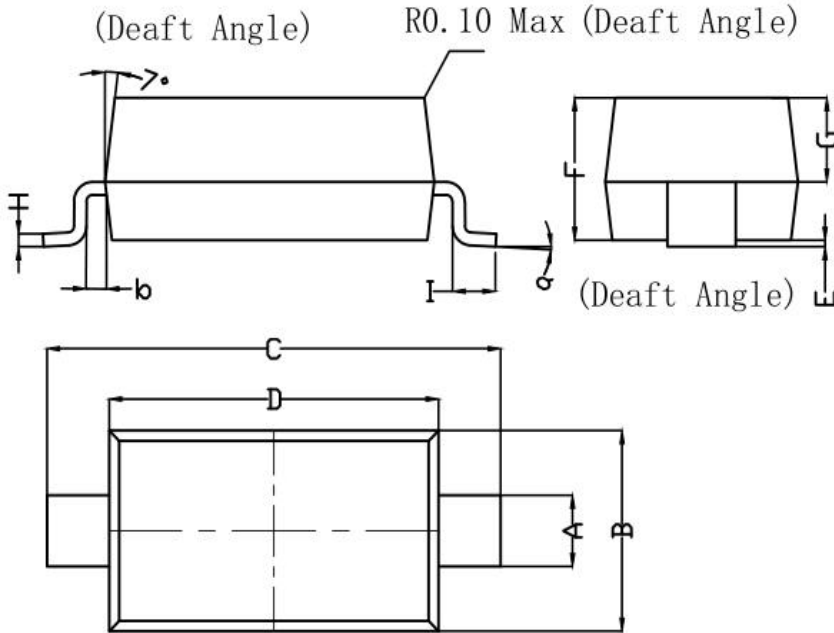

Symbol	Dim in mm		
	Min	Nom	Max
A	0.520	0.550	0.570
B	1.400	1.550	1.700
C	3.350	3.650	3.850
D	2.550	2.650	2.850
E	0.000	0.050	0.100
F	1.050	1.100	1.150
G	0.620	0.650	0.670
H	0.100	0.110	0.120
I	0.250	0.350	0.450
a	0°	-	6°
b	0.4°	-	0.8°

Mold Surface roughness <4um

出货规范/Shipping Specifications

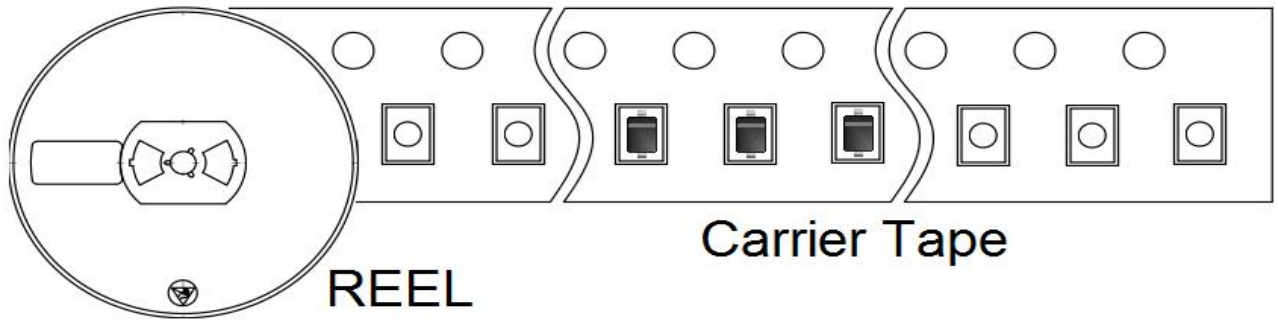

×15



×4



Reel	Reel Size	Box	Box Size(mm)	Carton	Carton size(mm)
3000 Pcs	7 inch	45 KPcs	185×185×188	180 KPcs	400×400×210